

BROOKHAVEN NATIONAL LABORATORY
 INSTRUMENTATION DIVISION
 BLDG. 535B
 UPTON N.Y. 11973

IMP BACK PLATE DB CONNECTION

Date: 19/01/2017:21:30
 DRAWN BY: Jack Fried

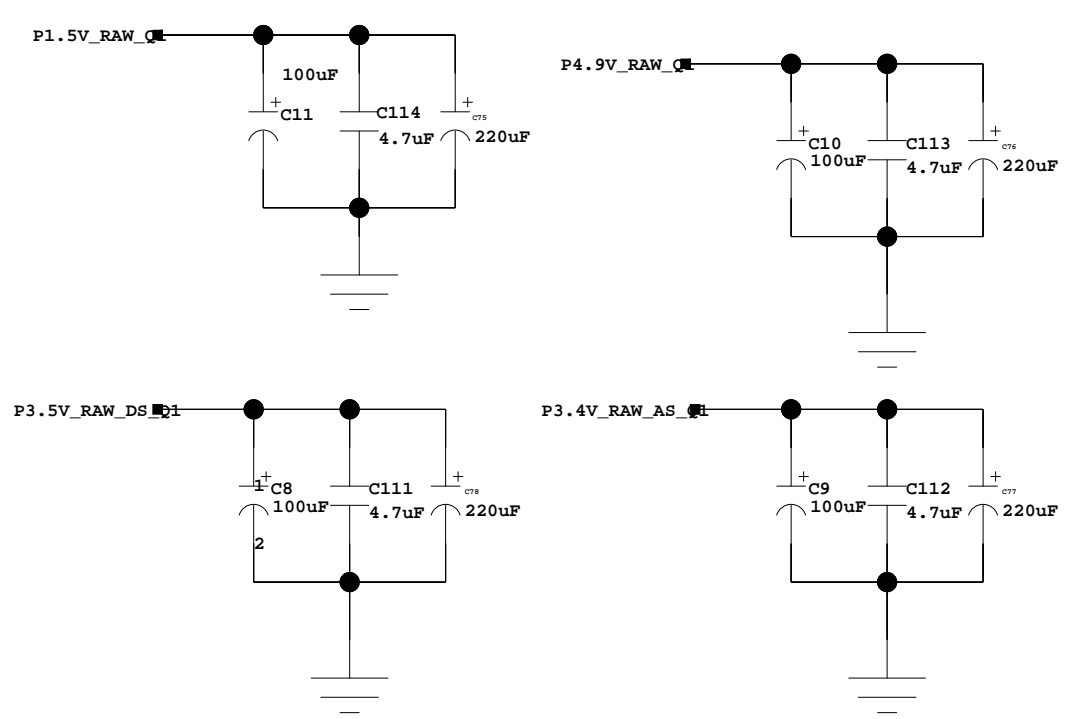
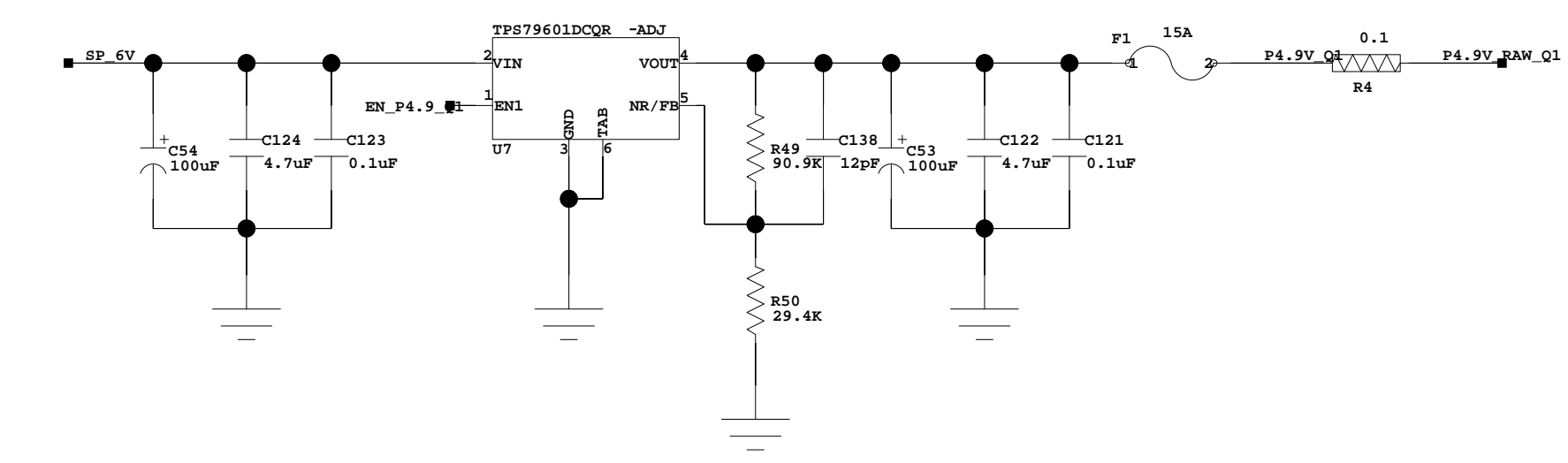
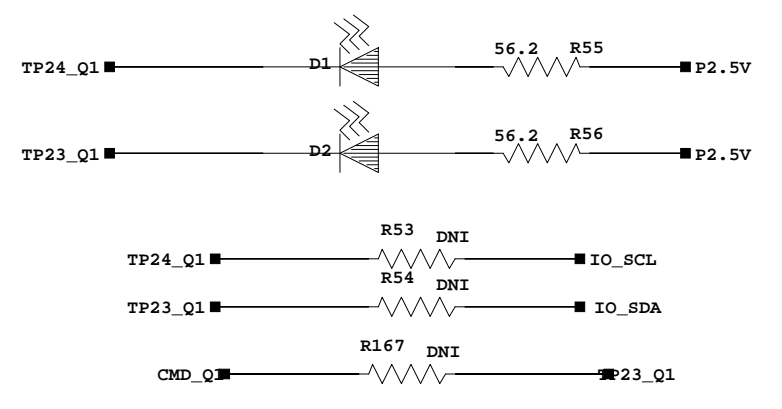
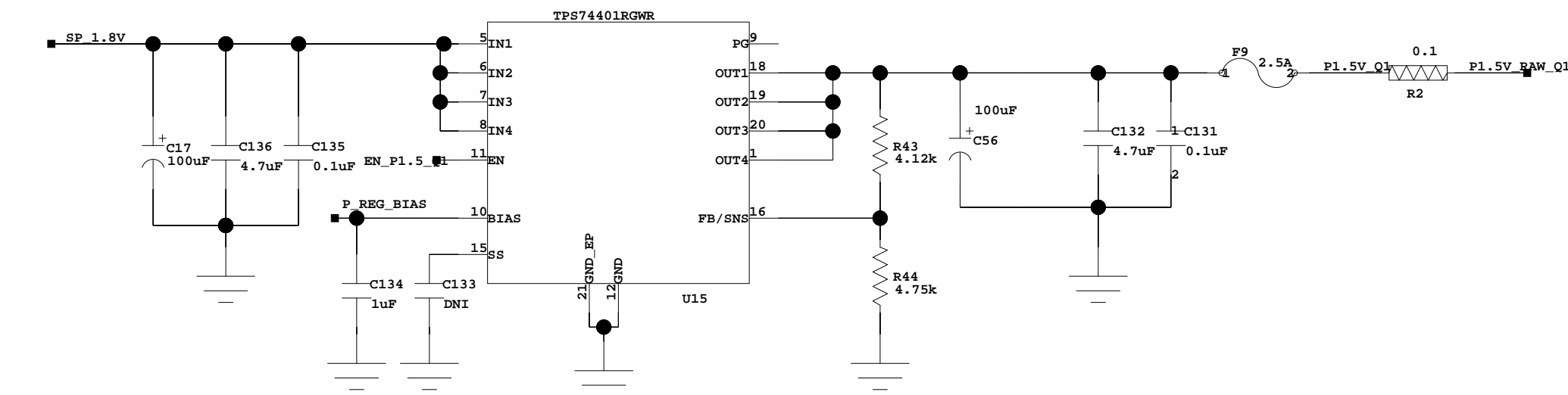
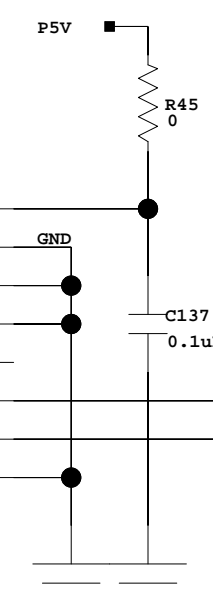
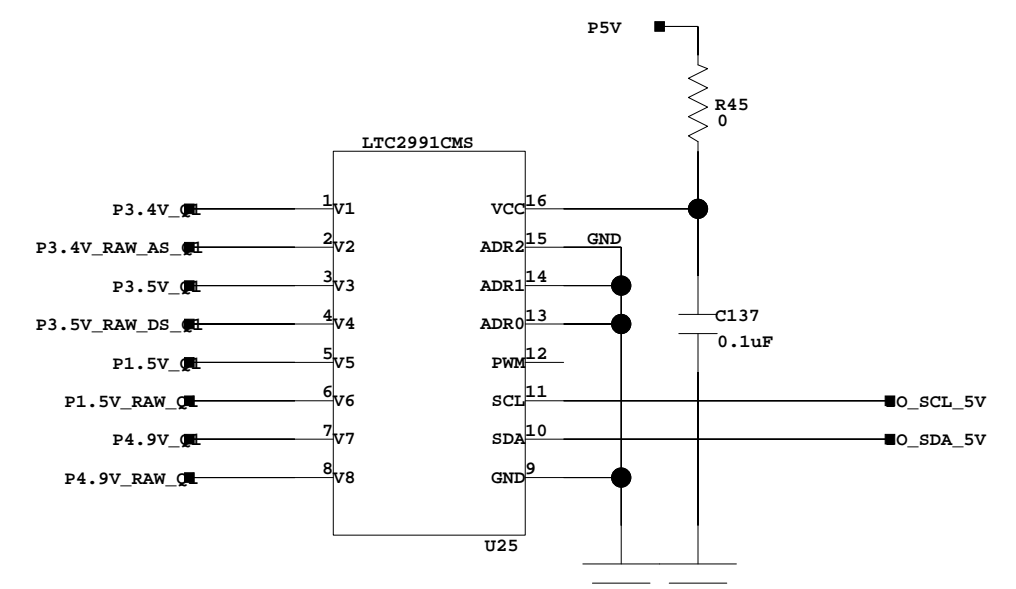
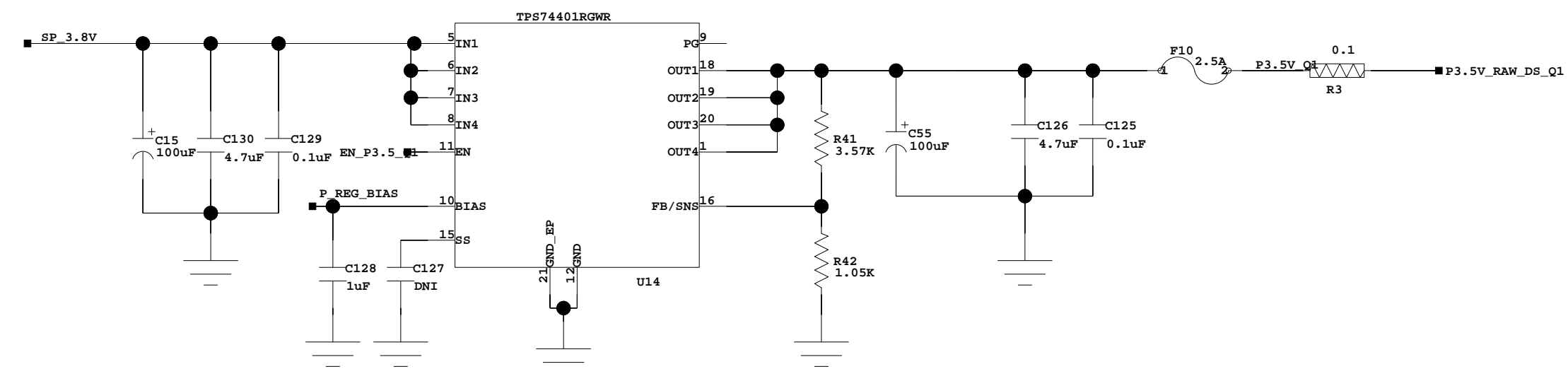
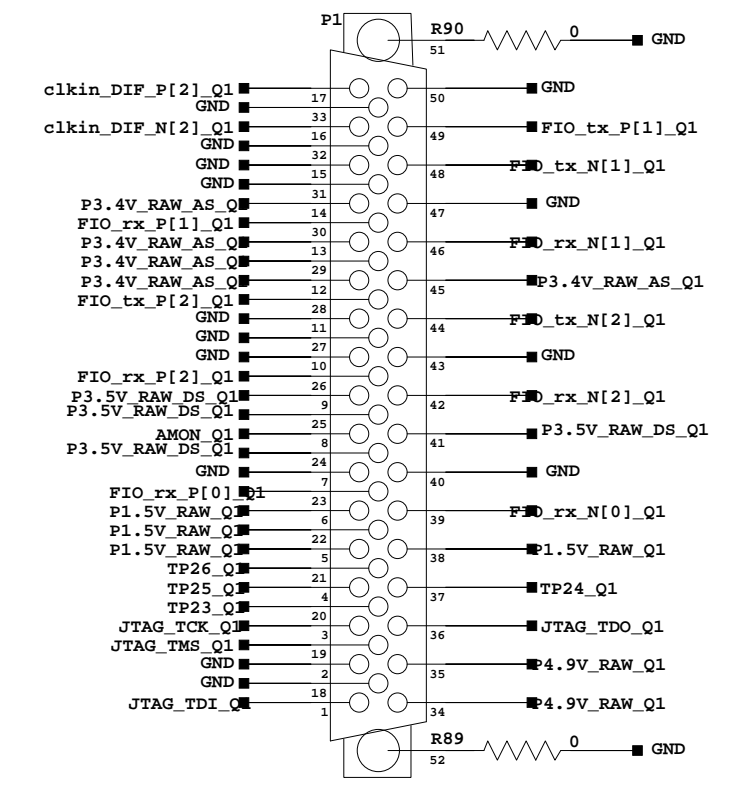
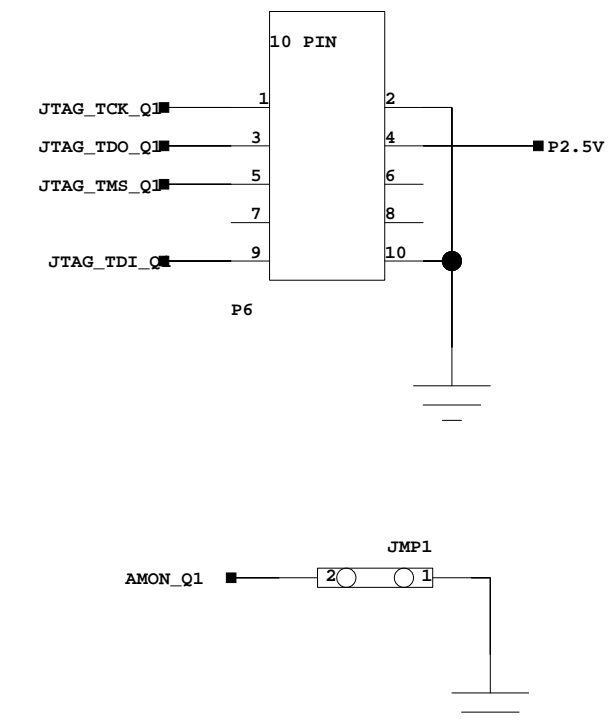
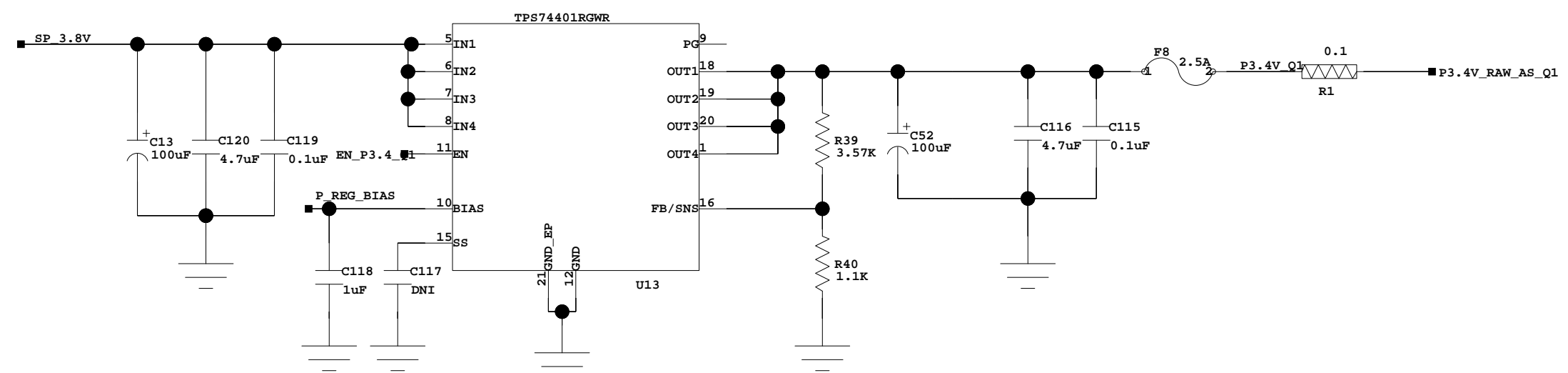

BROOKHAVEN NATIONAL LABORATORY
 INSTRUMENTATION DIVISION
 BLDG. 535B
 UPTON N.Y. 11973

IMP BACK PLATE

PWR & DB CONNECTION FOR QUADRANT ONE

Date: 19/01/2017:21:31
 DRAWN BY: Jack Fried

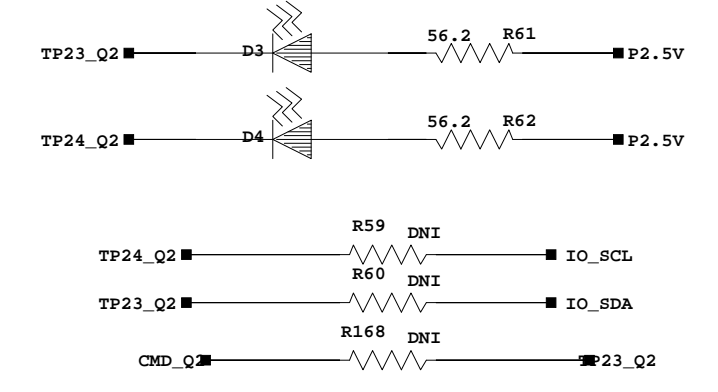
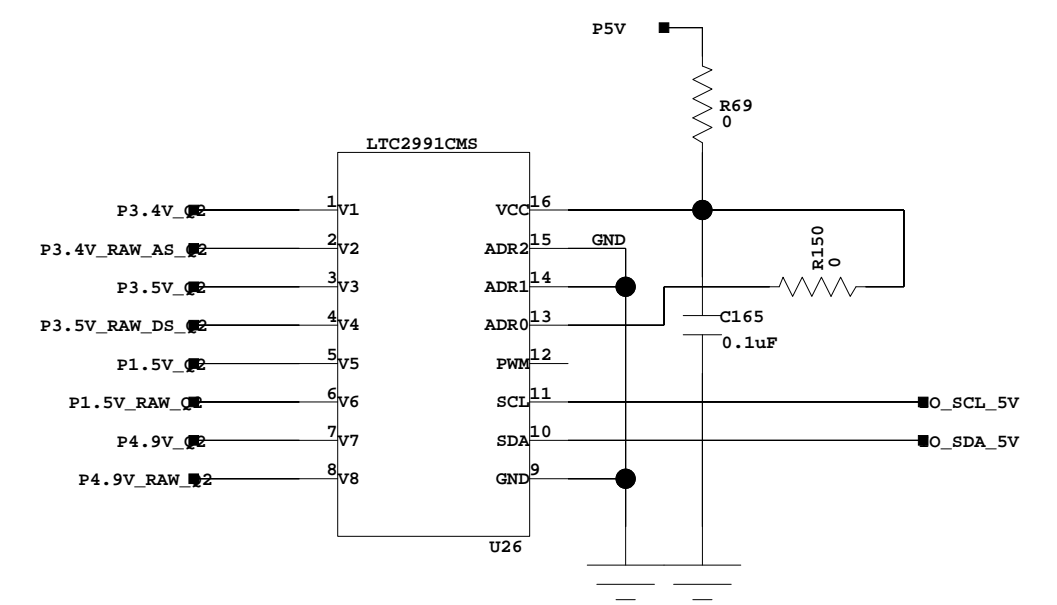
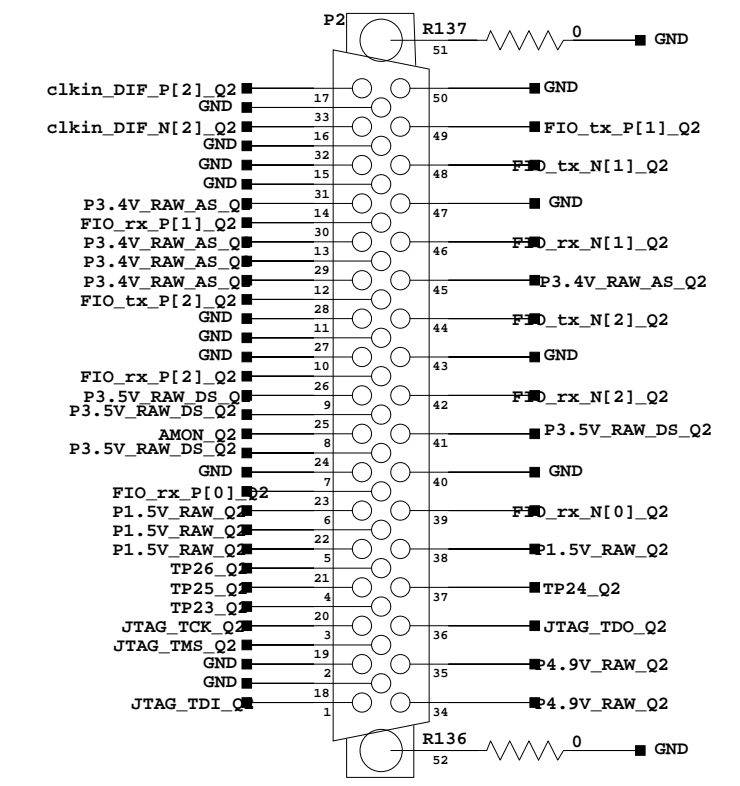
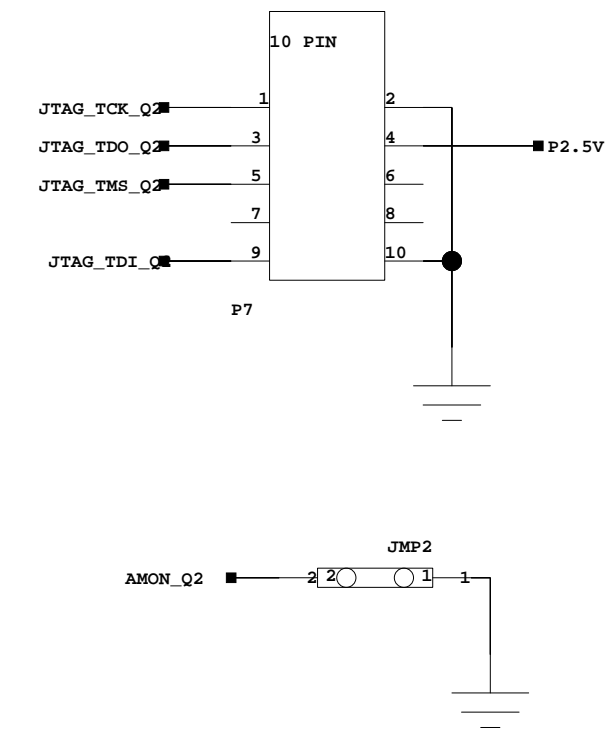
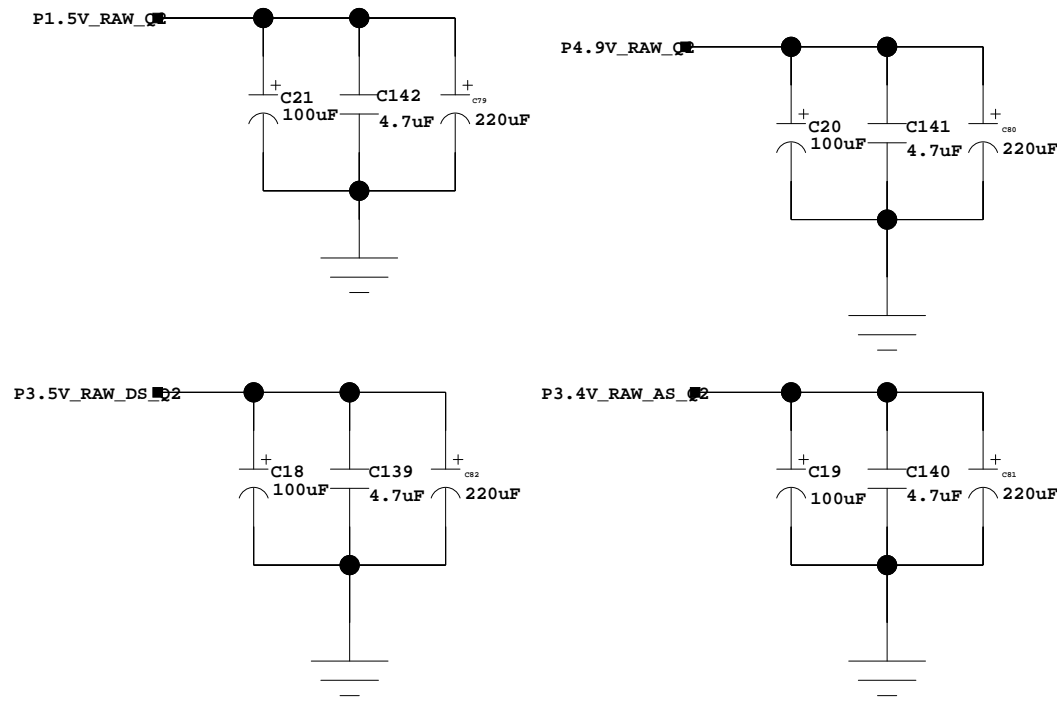
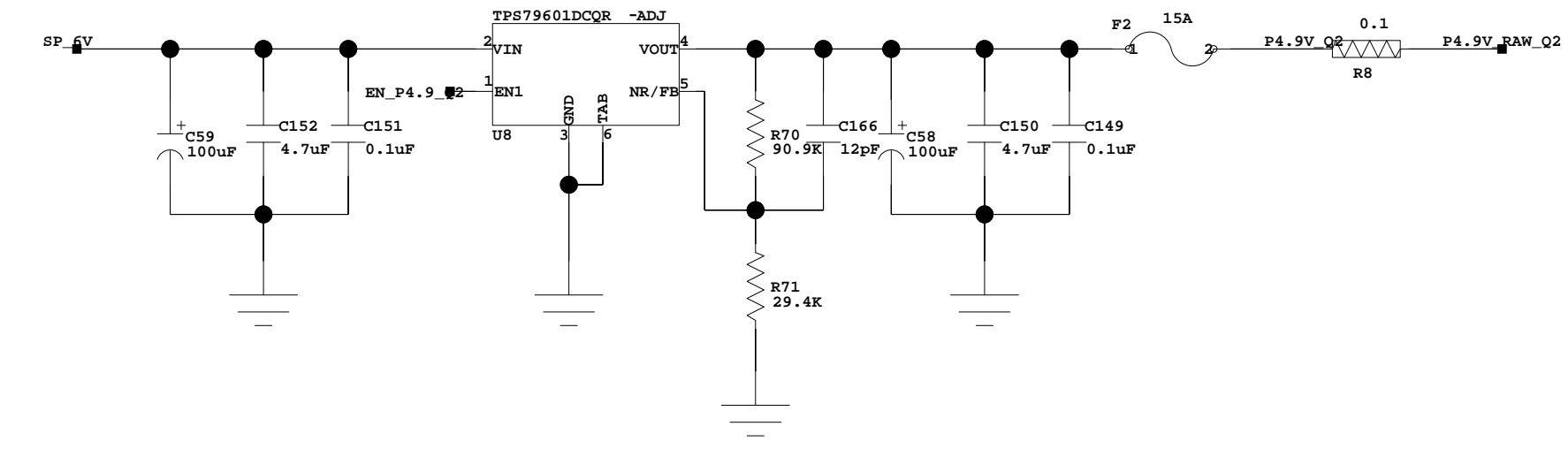
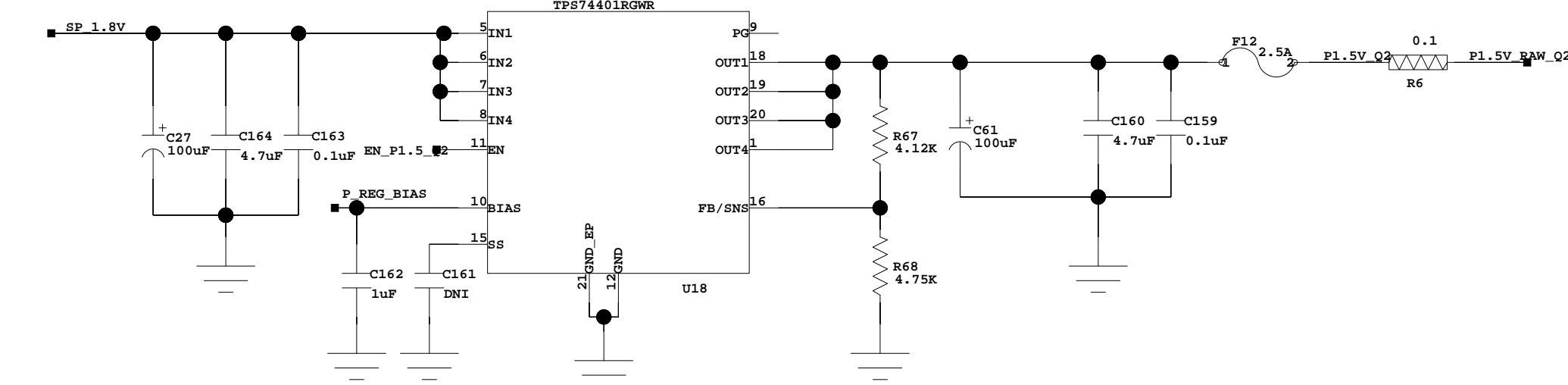
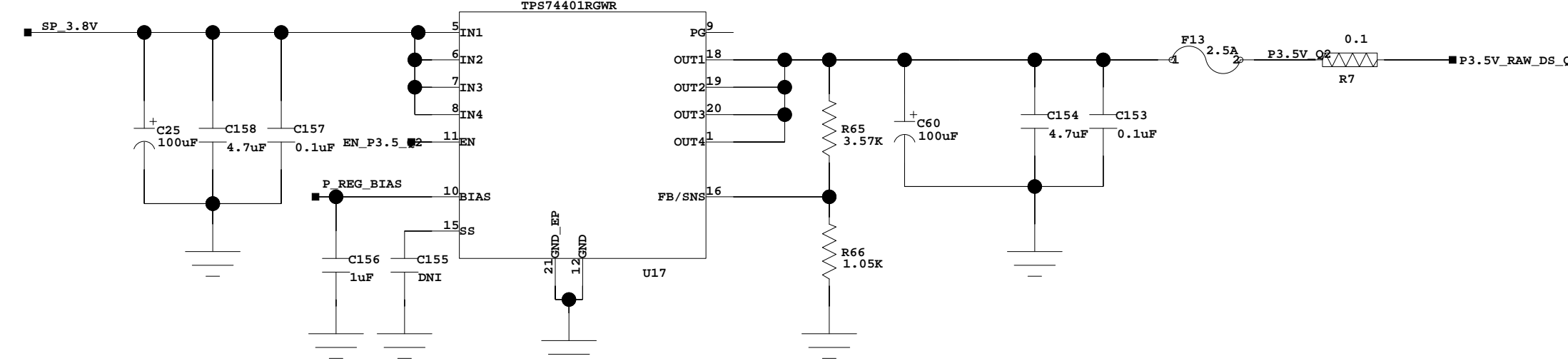
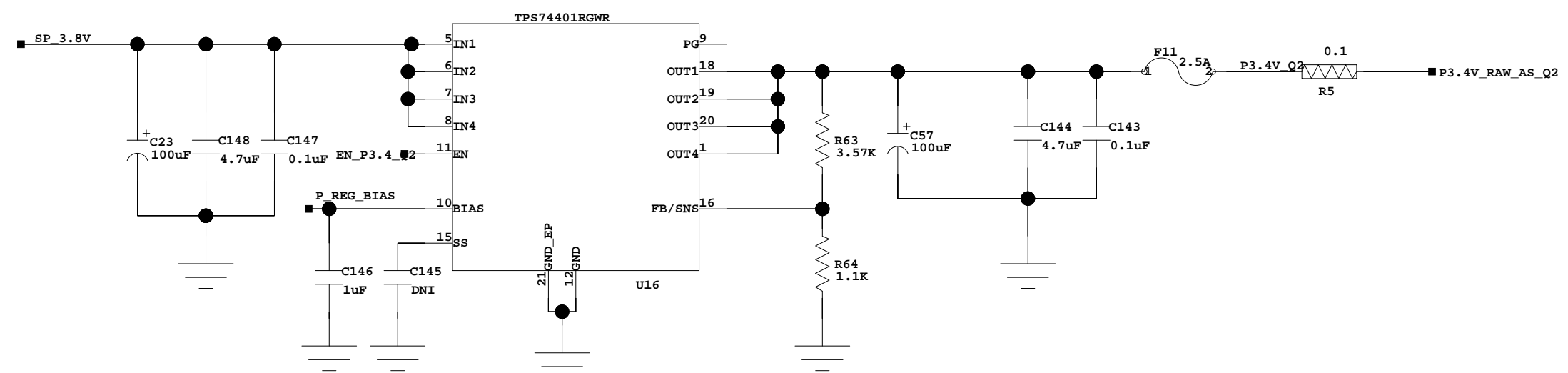

BROOKHAVEN NATIONAL LABORATORY
 INSTRUMENTATION DIVISION
 BLDG. 535B
 UPTON N.Y. 11973

IMP BACK PLATE DB CONNECTION

Date: 19/01/2017:21:14
 DRAWN BY: Jack Fried

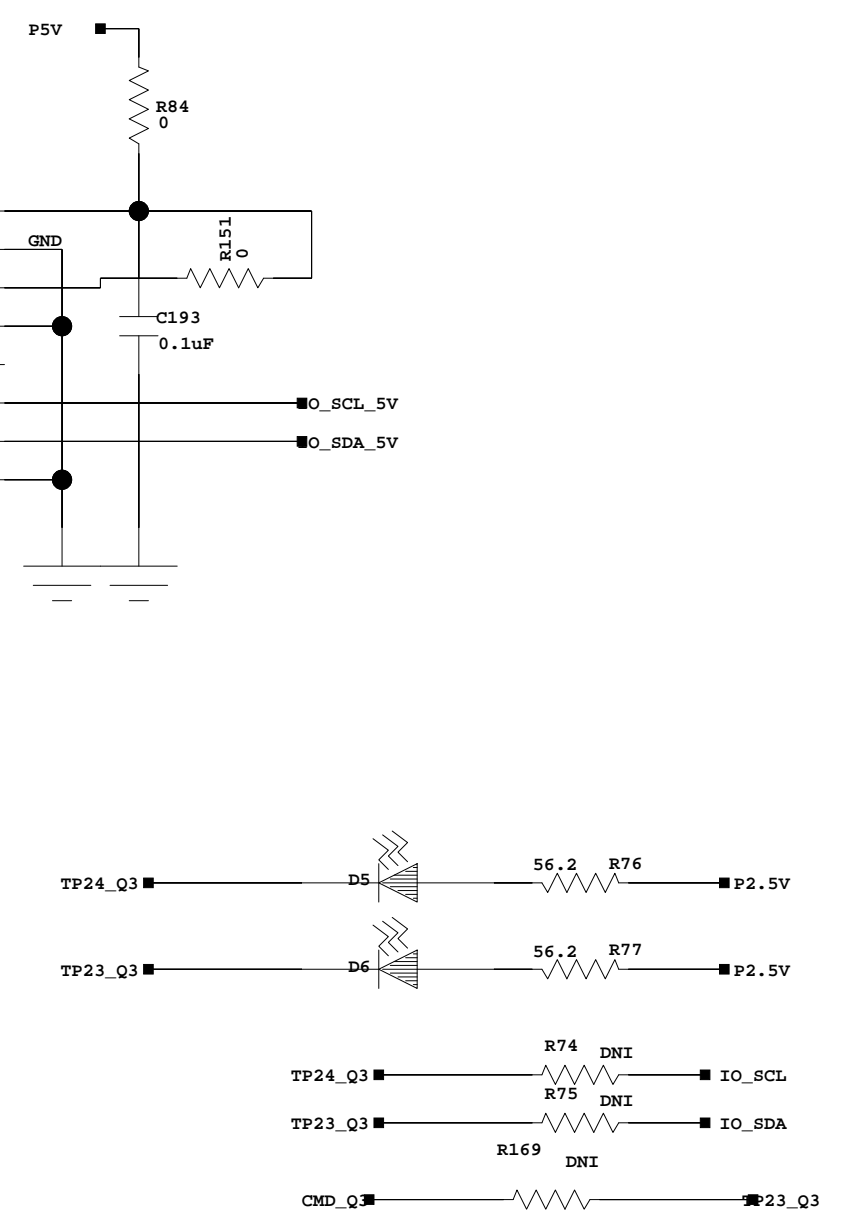
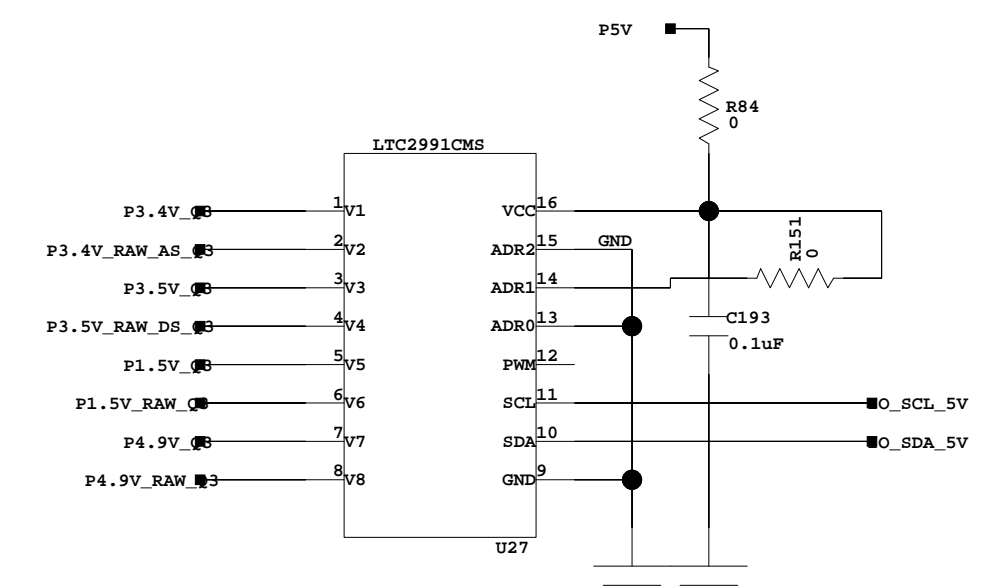
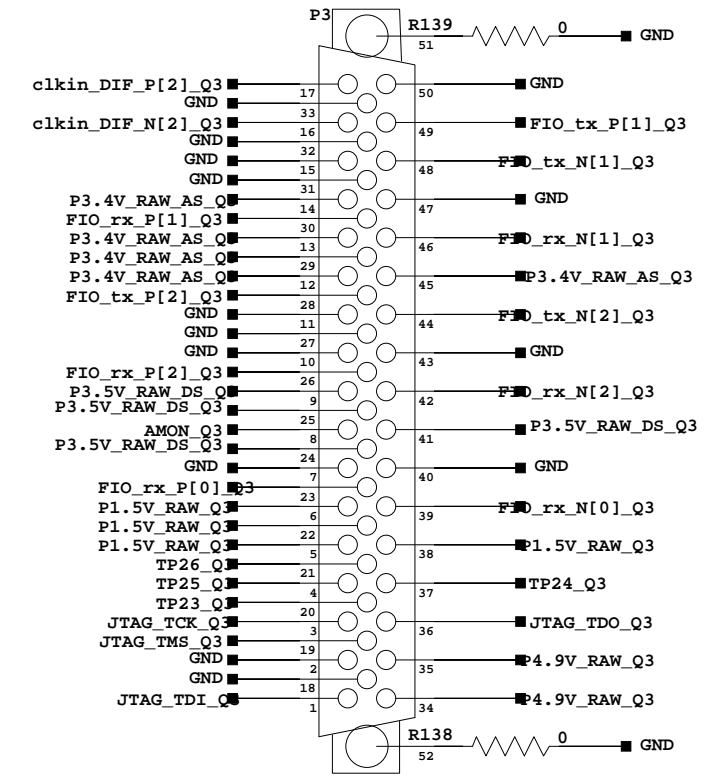
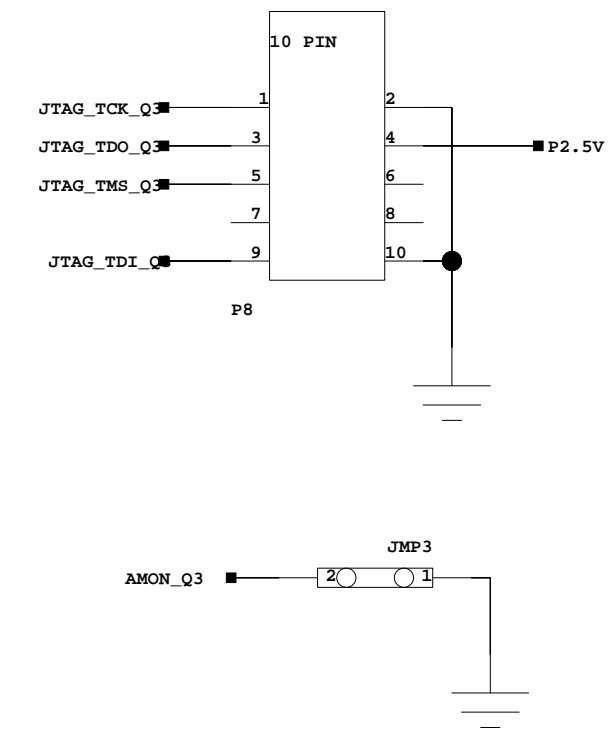
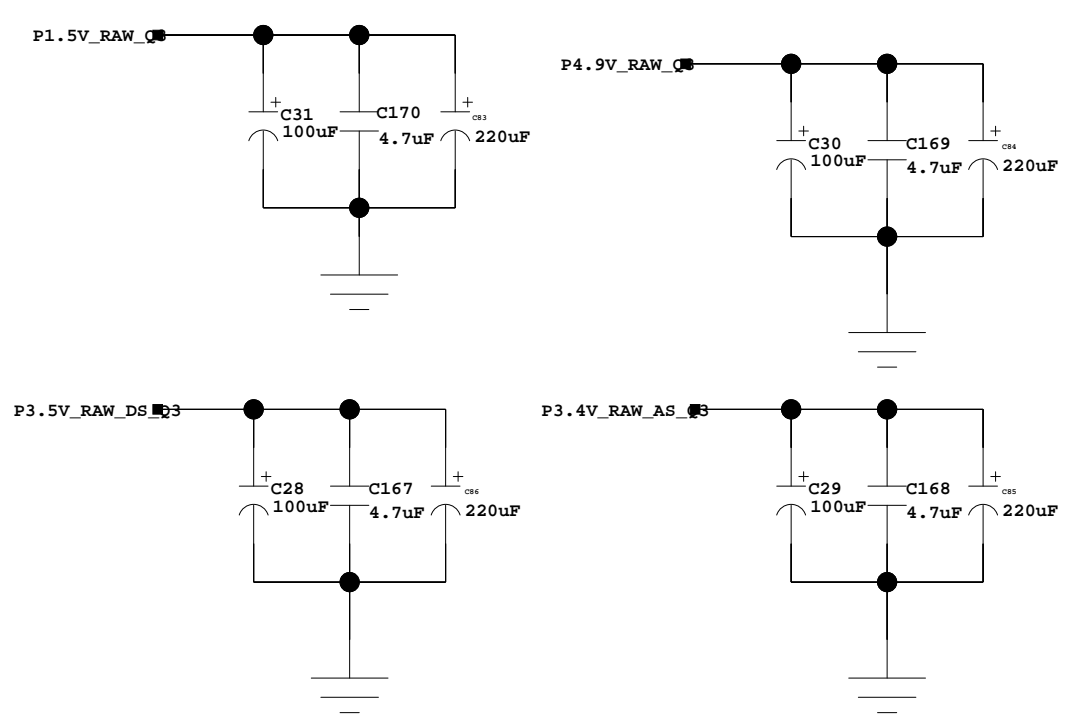
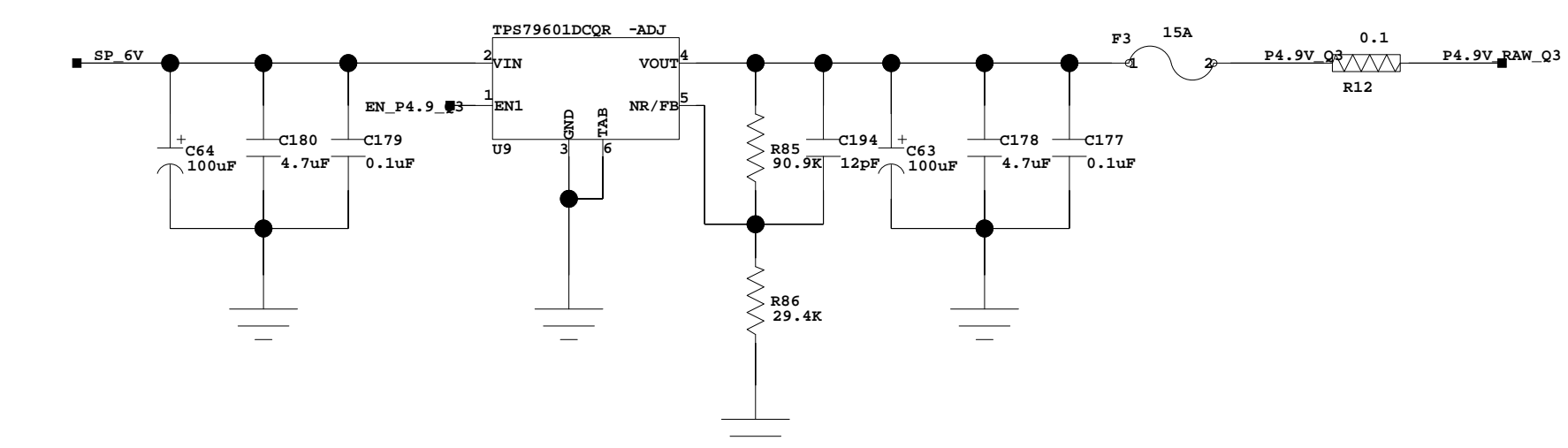
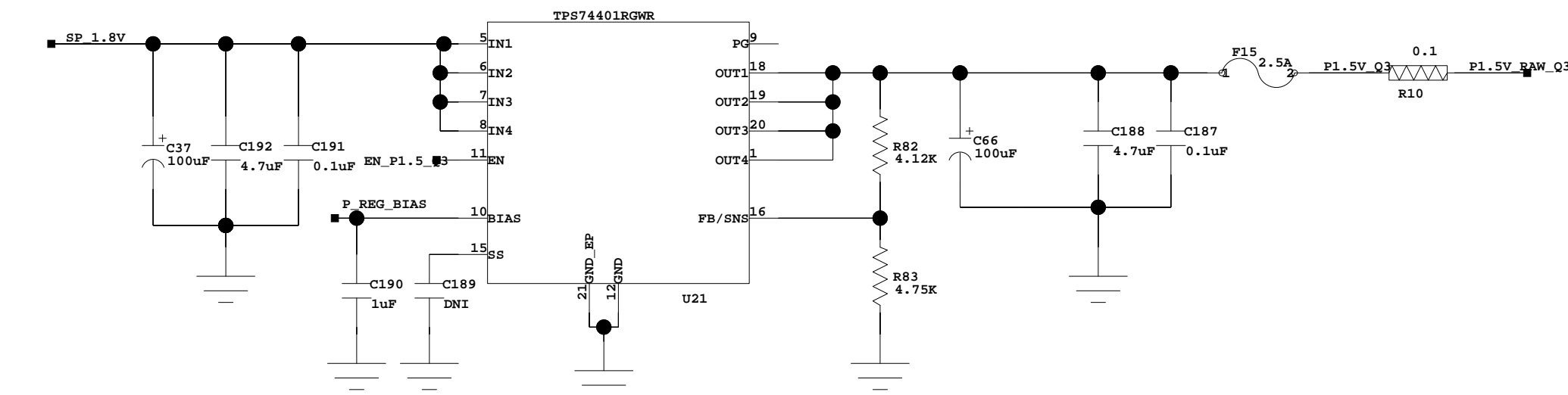
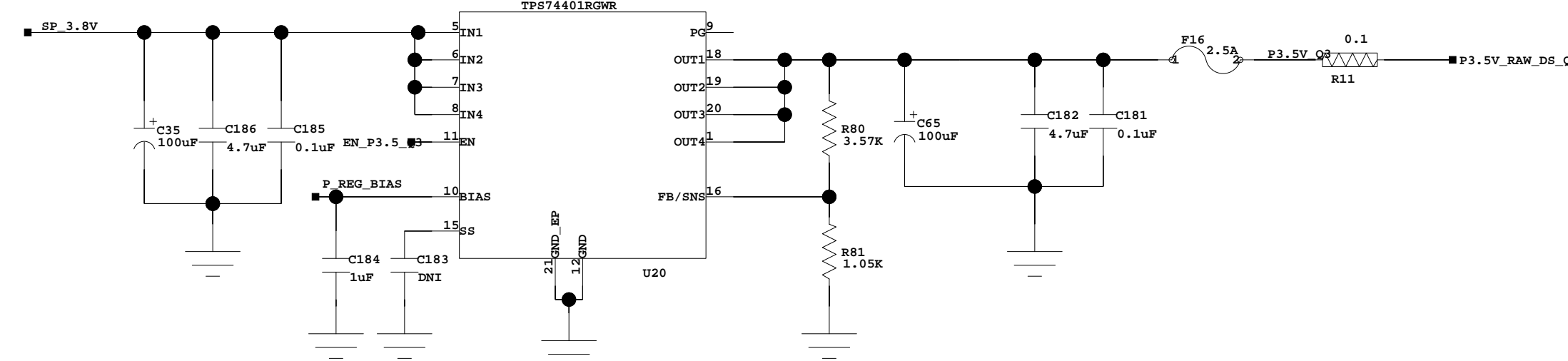
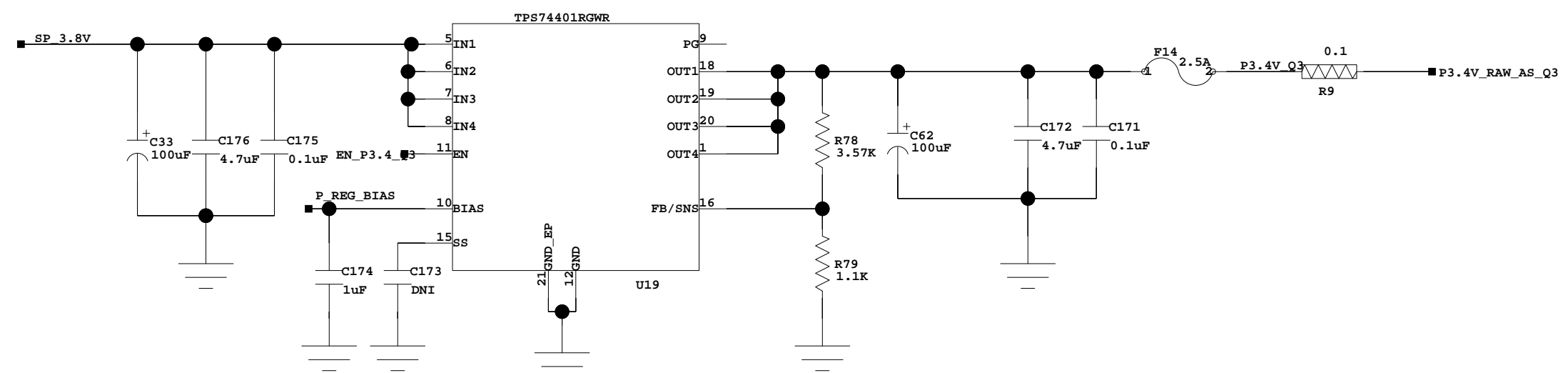

BROOKHAVEN NATIONAL LABORATORY
 INSTRUMENTATION DIVISION
 BLDG. 535B
 UPTON N.Y. 11973

IMP BACK PLATE DB CONNECTION

Date: 19/01/2017:21:31
 DRAWN BY: Jack Fried

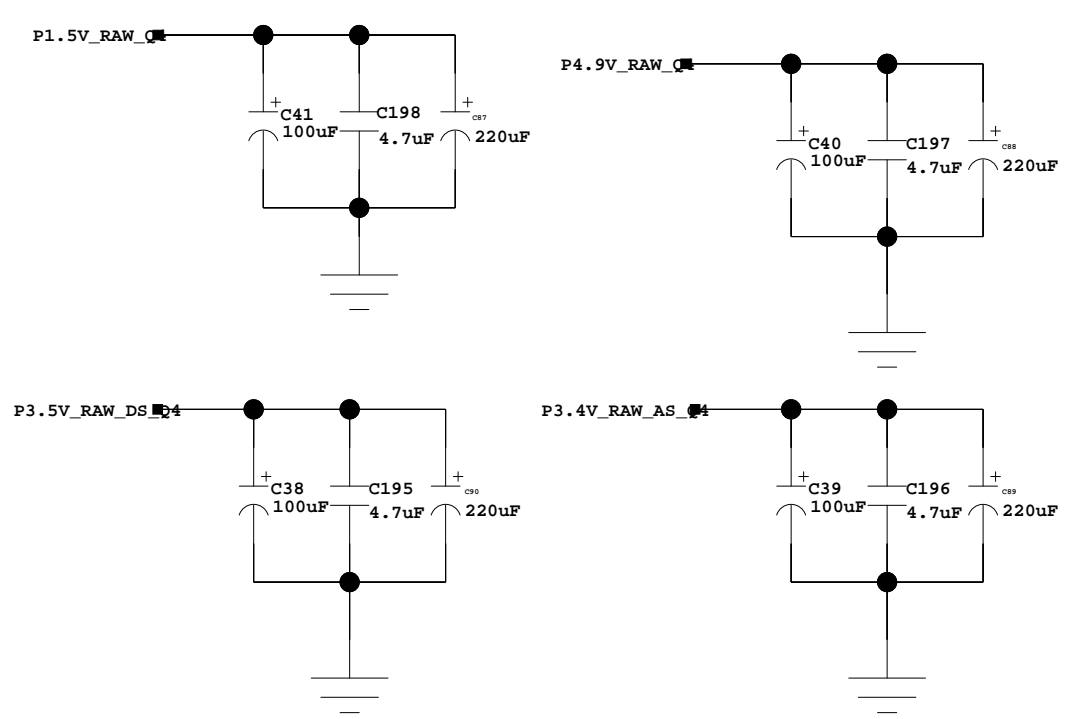
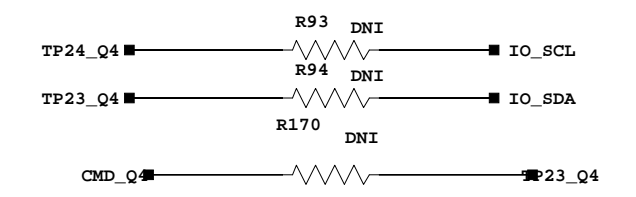
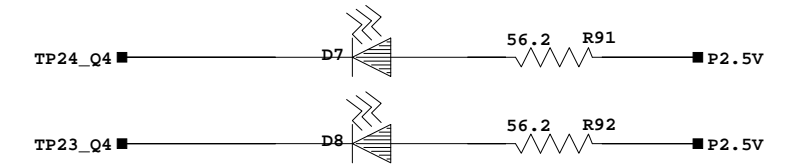
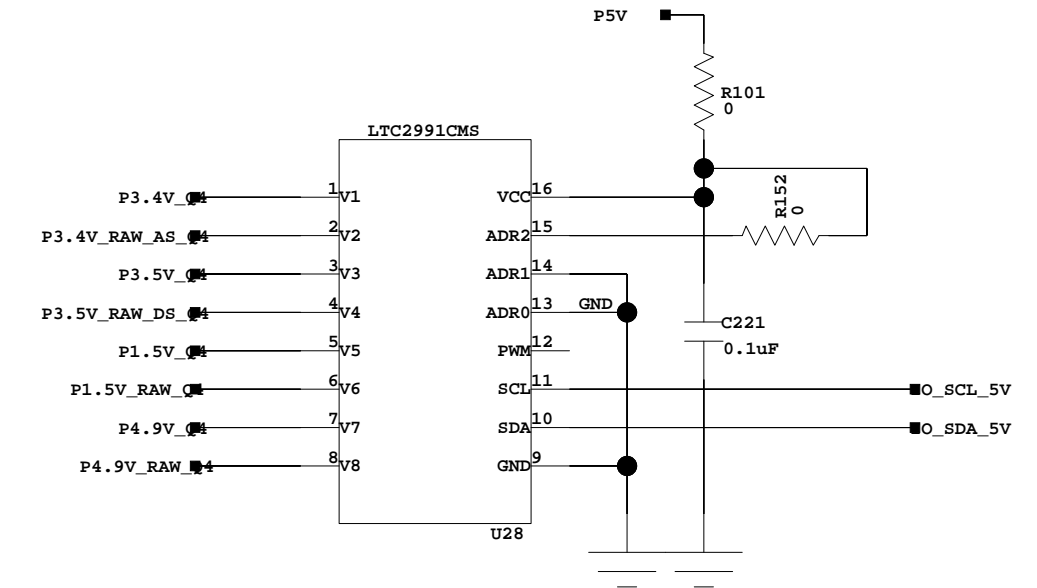
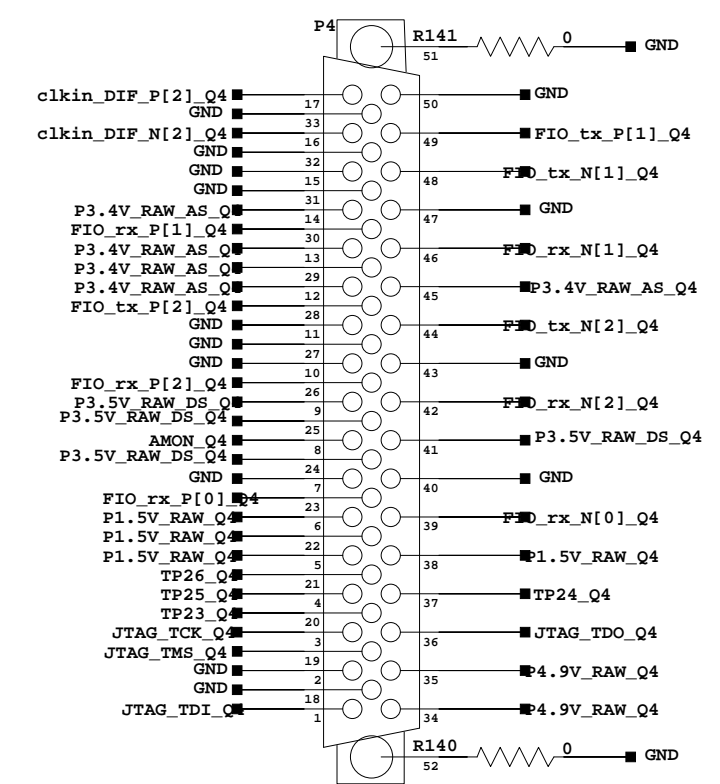
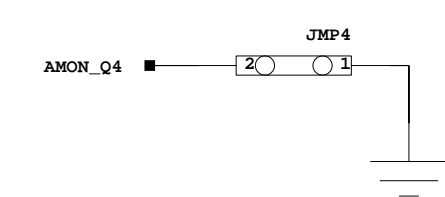
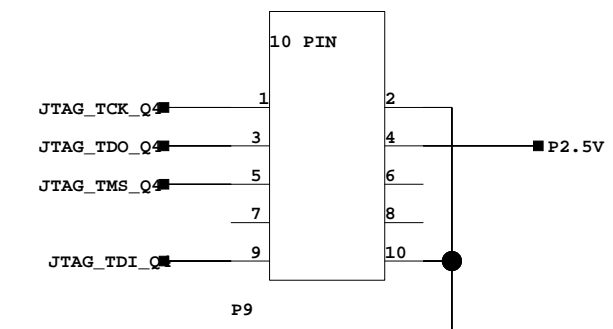
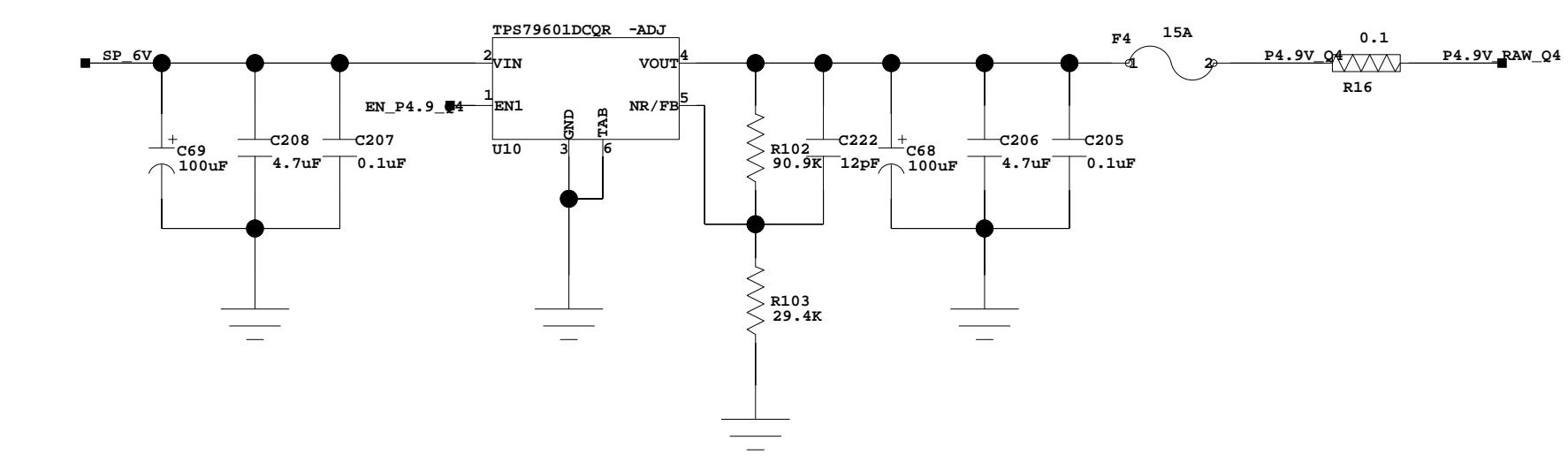
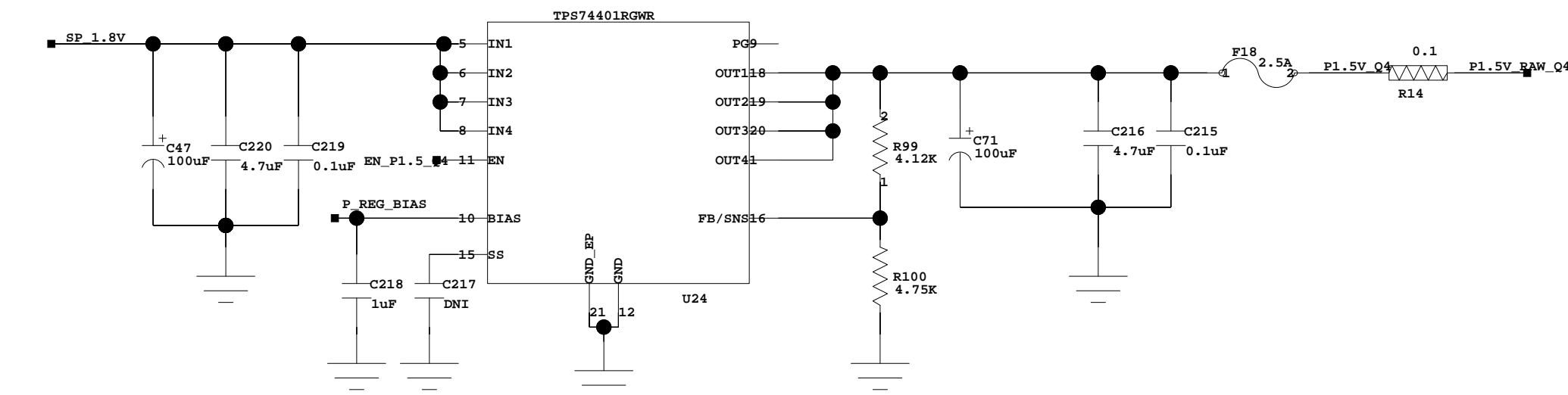
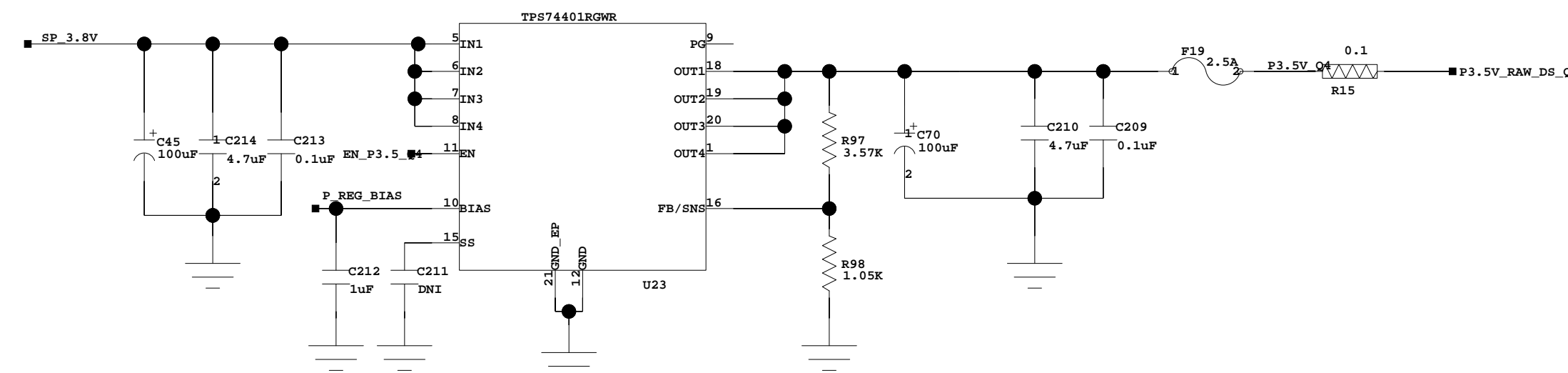
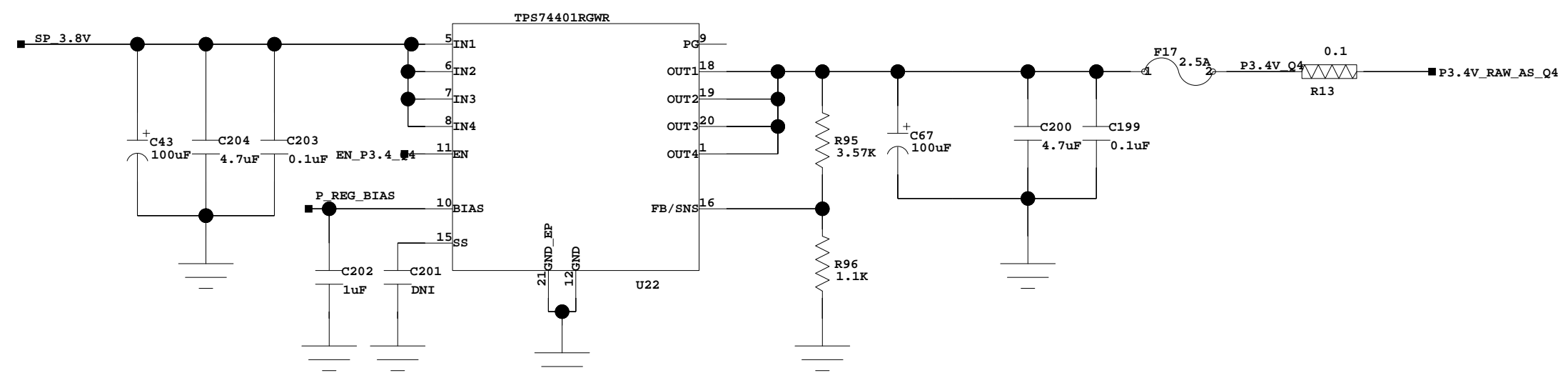

BROOKHAVEN NATIONAL LABORATORY
 INSTRUMENTATION DIVISION
 BLDG. 535B
 UPTON N.Y. 11973

IMP BACK PLATE DB CONNECTION

Date: 19/01/2017:21:31
 DRAWN BY: Jack Fried

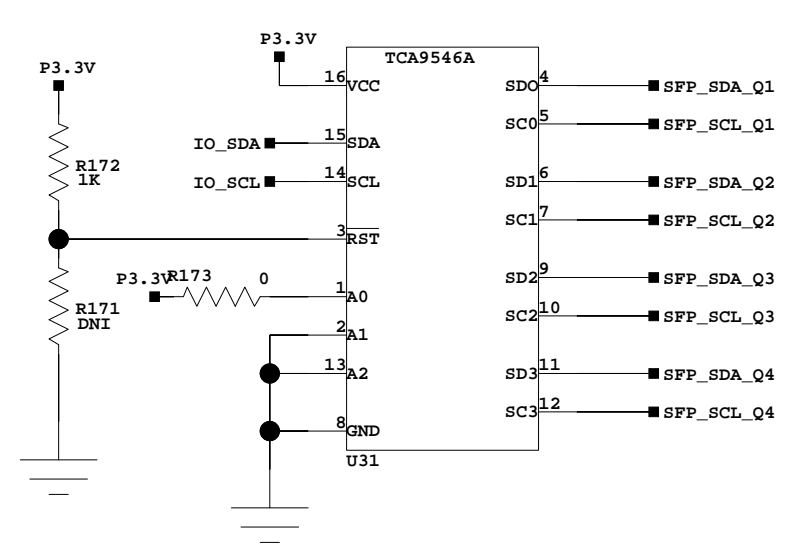
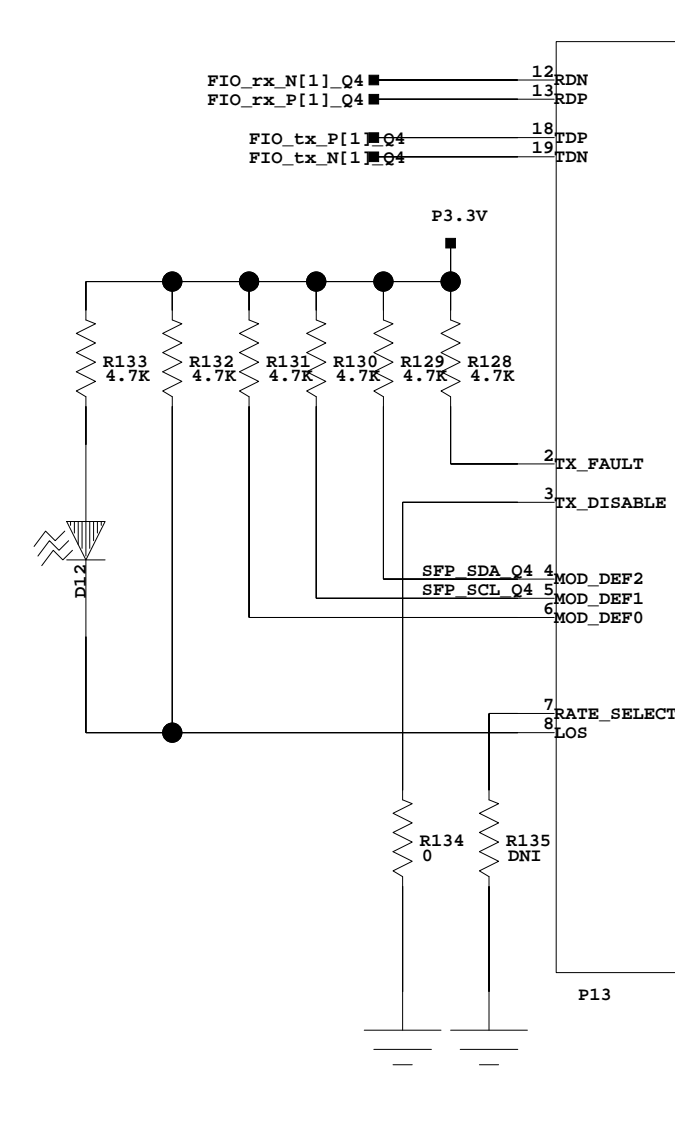
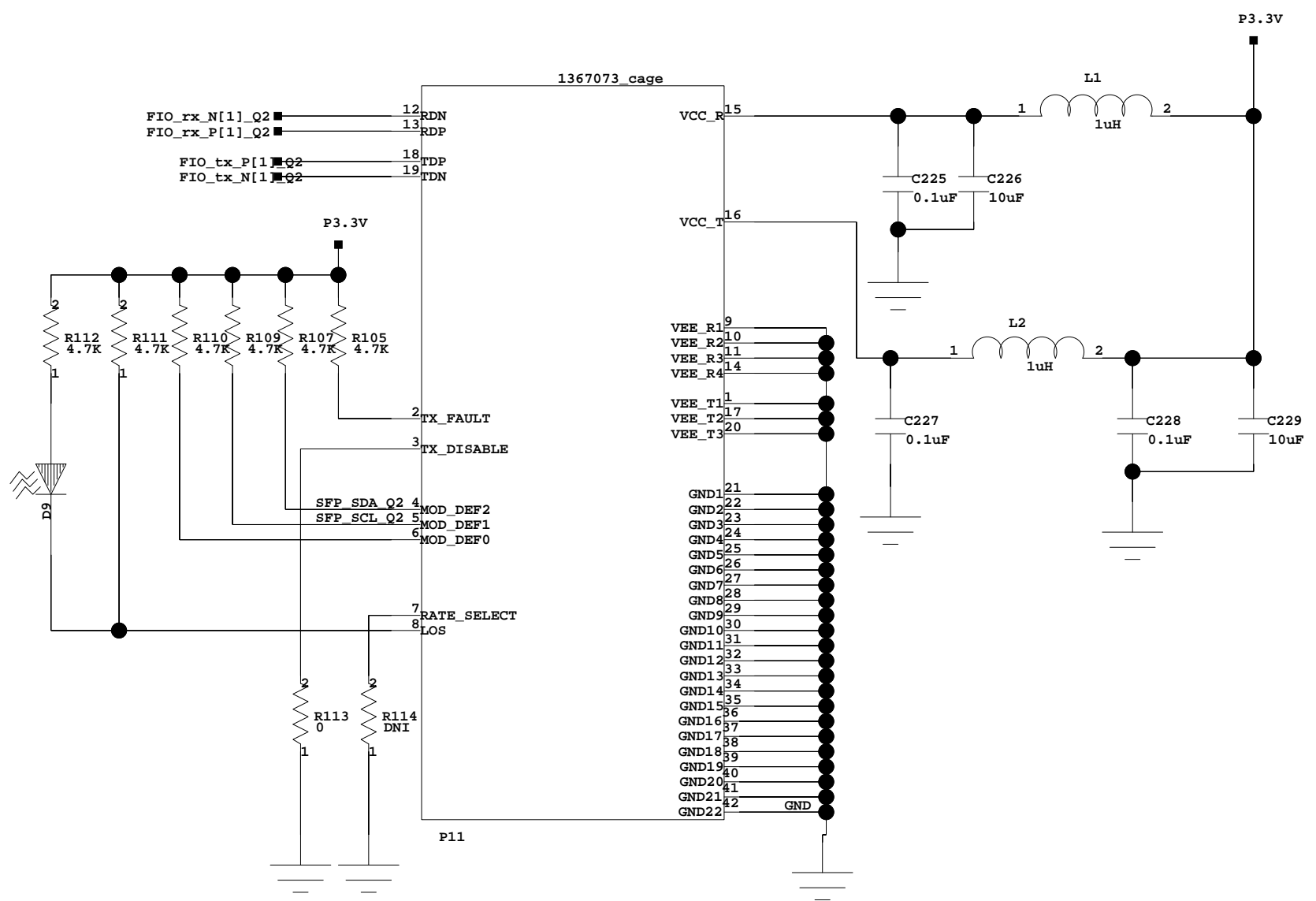
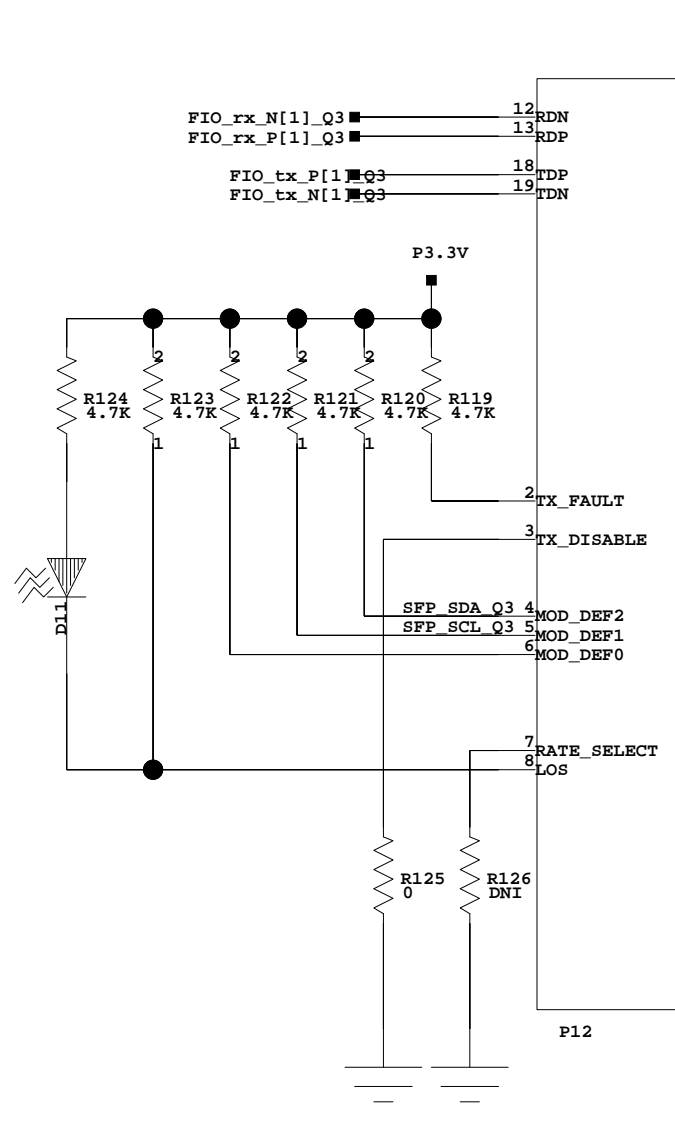
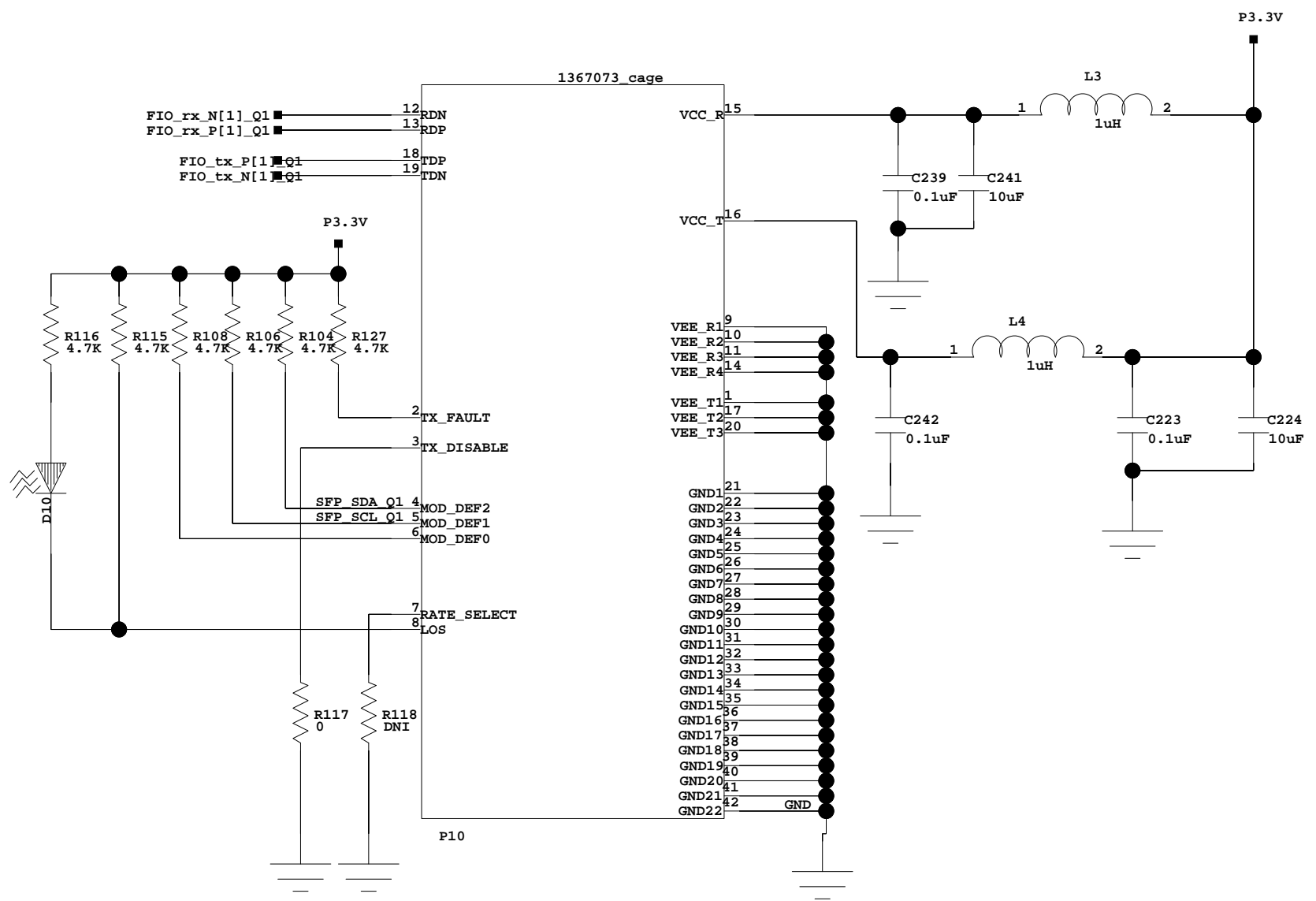

BROOKHAVEN NATIONAL LABORATORY
 INSTRUMENTATION DIVISION
 BLDG. 535B
 UPTON N.Y. 11973

Date: _____ DRAWN BY:
 Jack Fried